

Installation Instructions

CompactBlock Guard I/O EtherNet/IP Safety Modules

Catalog Numbers 1791ES-IB8XOBV4, 1791ES-IB16

Topic	Page
Important User Information	2
North American Hazardous Location Approval	3
Environment and Enclosure	4
Preventing Electrostatic Discharge	5
Before You Begin	6
Observing Precautions for Correct Use	7
Installing the Module	7
Setting Network Address	8
Mounting the Module	9
Module Identification and Dimensions	10
Wiring the Module	11
Working with Connectors	11
Observing Precautions for Safe Use	12
Interpret the Status Indicators	15
Terminal Positions	21
Specifications	23

Important User Information

Solid state equipment has operational characteristics differing from those of electromechanical equipment. Safety Guidelines for the Application, Installation and Maintenance of Solid State Controls (Publication SGI-1.1 available from your local Rockwell Automation sales office or online at <http://www.rockwellautomation.com/literature/>) describes some important differences between solid state equipment and hard-wired electromechanical devices. Because of this difference, and also because of the wide variety of uses for solid state equipment, all persons responsible for applying this equipment must satisfy themselves that each intended application of this equipment is acceptable.





In no event will Rockwell Automation, Inc. be responsible or liable for indirect or consequential damages resulting from the use or application of this equipment.

The examples and diagrams in this manual are included solely for illustrative purposes. Because of the many variables and requirements associated with any particular installation, Rockwell Automation, Inc. cannot assume responsibility or liability for actual use based on the examples and diagrams.



No patent liability is assumed by Rockwell Automation, Inc. with respect to use of information, circuits, equipment, or software described in this manual.

Reproduction of the contents of this manual, in whole or in part, without written permission of Rockwell Automation, Inc., is prohibited.

Throughout this manual, when necessary, we use notes to make you aware of safety considerations.

WARNING 	Identifies information about practices or circumstances that can cause an explosion in a hazardous environment, which may lead to personal injury or death, property damage, or economic loss.
IMPORTANT	Identifies information that is critical for successful application and understanding of the product.
ATTENTION 	Identifies information about practices or circumstances that can lead to personal injury or death, property damage, or economic loss. Attentions help you identify a hazard, avoid a hazard and recognize the consequences.
SHOCK HAZARD 	Labels may be on or inside the equipment, for example, drive or motor, to alert people that dangerous voltage may be present.
BURN HAZARD 	Labels may be on or inside the equipment, for example, drive or motor, to alert people that surfaces may reach dangerous temperatures.

North American Hazardous Location Approval

<p>The following information applies when operating this equipment in hazardous locations.</p>	<p>Informations sur l'utilisation de cet équipement en environnements dangereux.</p>		
<p>Products marked "CL I, DIV 2, GP A, B, C, D" are suitable for use in Class I Division 2 Groups A, B, C, D, hazardous locations and nonhazardous locations only. Each product is supplied with markings on the rating nameplate indicating the hazardous location temperature code. When combining products within a system, the most adverse temperature code (lowest "T" number) may be used to help determine the overall temperature code of the system. Combinations of equipment in your system are subject to investigation by the local Authority Having Jurisdiction at the time of installation.</p>	<p>Les produits marqués "CL I, DIV 2, GP A, B, C, D" ne conviennent qu'à une utilisation en environnements de Classe I Division 2 Groupes A, B, C, D dangereux et non dangereux. Chaque produit est livré avec des marquages sur sa plaque d'identification qui indiquent le code de température pour les environnements dangereux. Lorsque plusieurs produits sont combinés dans un système, le code de température le plus défavorable (code de température le plus faible) peut être utilisé pour déterminer le code de température global du système. Les combinaisons d'équipements dans le système sont sujettes à inspection par les autorités locales qualifiées au moment de l'installation.</p>		
<p>WARNING</p> 	<p>EXPLOSION HAZARD -</p> <ul style="list-style-type: none"> • Do not disconnect equipment unless power has been removed or the area is known to be nonhazardous. • Do not disconnect connections to this equipment unless power has been removed or the area is known to be nonhazardous. Secure any external connections that mate to this equipment by using screws, sliding latches, threaded connectors, or other means provided with this product. • Substitution of components may impair suitability for Class I, Division 2. • If this product contains batteries, they must only be changed in an area known to be nonhazardous. 	<p>AVERTISSEMENT</p> 	<p>RISQUE D'EXPLOSION –</p> <ul style="list-style-type: none"> • Couper le courant ou s'assurer que l'environnement est classé non dangereux avant de débrancher l'équipement. • Couper le courant ou s'assurer que l'environnement est classé non dangereux avant de débrancher les connecteurs. Fixer tous les connecteurs externes reliés à cet équipement à l'aide de vis, loquets coulissants, connecteurs filetés ou autres moyens fournis avec ce produit. • La substitution de composants peut rendre cet équipement inadapté à une utilisation en environnement de Classe 1, Division 2. • S'assurer que l'environnement est classé non dangereux avant de changer les piles.

WARNING



When you change switch settings while power is on, an electrical arc can occur. This could cause an explosion in hazardous location installations. Be sure that power is removed or the area is nonhazardous before proceeding.

Environment and Enclosure

ATTENTION

This equipment is intended for use in a Pollution Degree 2 industrial environment, in overvoltage Category II applications (as defined in IEC 60664-1), at altitudes up to 2000 m (6562 ft) without derating.

This equipment is considered Group 1, Class A industrial equipment according to IEC/CISPR Publication 11. Without appropriate precautions, there may be potential difficulties with electromagnetic compatibility in residential and other environments due to conducted and radiated disturbances.

This equipment is supplied as open-type equipment. It must be mounted within an enclosure that is suitably designed for those specific environmental conditions that will be present and appropriately designed to prevent personal injury resulting from accessibility to live parts. The enclosure must have suitable flame-retardant properties to prevent or minimize the spread of flame, complying with a flame spread rating of 5VA, V2, V1, V0 (or equivalent) if non-metallic. The interior of the enclosure must be accessible only by the use of a tool. Subsequent sections of this publication may contain additional information regarding specific enclosure type ratings that are required to comply with certain product safety certifications.

Besides this publication, see:

- Industrial Automation Wiring and Grounding Guidelines, for additional installation requirements, publication [1770-4.1](#).
 - NEMA Standards 250 and IEC 60529, as applicable, for explanations of the degrees of protection provided by different types of enclosure.
-

Preventing Electrostatic Discharge

ATTENTION

This equipment is sensitive to electrostatic discharge, which can cause internal damage and affect normal operation. Follow these guidelines when you handle this equipment:

- Touch a grounded object to discharge potential static.
- Wear an approved grounding wriststrap.
- Do not touch connectors or pins on component boards.
- Do not touch circuit components inside the equipment.
- Use a static-safe workstation, if available.
- Store the equipment in appropriate static-safe packaging when not in use.

WARNING

When you connect or disconnect the removable terminal block (RTB) with field-side power applied, an electrical arc can occur. This could cause an explosion in hazardous location installations. Be sure that power is removed or the area is nonhazardous before proceeding.

WARNING

If you connect or disconnect wiring while the field-side power is on, an electrical arc can occur. This could cause an explosion in hazardous location installations. Be sure that power is removed or the area is nonhazardous before proceeding

ATTENTION

Personnel responsible for the application of safety-related programmable electronic systems (PES) shall be aware of the safety requirements in the application of the system and shall be trained in using the system.

WARNING

If you connect or disconnect the communication cable with power applied to this module or any device on the network, an electrical arc can occur. This could cause an explosion in hazardous location installations.

ATTENTION

To comply with the CE Low Voltage Directive (LVD), this equipment and all connected I/O must be powered from a safety extra-low voltage (SELV) or protected extra-low voltage (PELV) compliant source.

Before You Begin

Before installing and operating the product, read these installation instructions to learn important installation-related information and the precautions to follow as you install and operate the product. Keep these instructions for future reference.

Concerning suitability for use, note that we are not responsible for conformity with any standards, codes, or regulations that apply to the combination of the products in the customer's application or use of the product. Take all necessary steps to determine the suitability of the product for the systems, machine, and equipment with which it will be used. Know and observe all prohibitions of use applicable to this product.

Never use the products for an application involving serious risk to life or property without ensuring that the system as a whole has been designed to address the risks and that the Rockwell Automation product is properly rated and installed for the intended use within the overall equipment or system.

Observing Precautions for Correct Use

The following information is related to operating directions. Refer to this information after reading the user manual that covers these modules.

Do not use the unit in locations subject to the following:

- Direct sunlight
- Temperatures or humidity beyond the ranges noted in the Specifications section
- Condensation as the result of severe changes in temperature
- Corrosive or flammable gases
- Dust (especially iron dust) or salts
- Water, oil, or chemicals
- Shock or vibration beyond the range noted in the Specifications section

Installing the Module

Read this section for installation-related information.

Setting Network Address

Set network (IP address). The module ships with the rotary switches set to 999 and DHCP enabled. To change the network address, you can:

- adjust the switches on the front of the module.
- use a Dynamic Host Configuration Protocol (DHCP) server, such as Rockwell Automation BootP/DHCP.
- retrieve the IP address from nonvolatile memory.

The module reads the switches first to determine if the switches are set to a valid number. You set the network address by adjusting the three switches on the front of the module, noting that you:

- use a screwdriver to rotate the switches.
- line up the small notch on the switch with the number setting you wish to use, with valid settings ranging from 001...254.

When the switches are set to a valid number, the module's IP address is 192.168.1.xxx (where xxx represents the number set on the switches). The module's subnet mask is 255.255.255.0 and the gateway address is set to 0.0.0.0.

When the module is reading the network address set on the switches, the module does not have a host name assigned to it or use any Domain Name System.

If the switches are set to an invalid number (such as 000 or a value greater than 254), the module checks to see if DHCP is enabled. If DHCP is enabled, the module asks for an address from a DHCP server. The DHCP server also assigns other transport control protocol (TCP) parameters. If DHCP is not enabled, the module uses the IP address (along with other TCP configurable parameters) stored in nonvolatile memory.

Network Address Example

This example shows the network address set at 163.

X100



X10



X1



Mounting the Module

ATTENTION



This product is grounded through the DIN rail to chassis ground. Use zinc plated yellow-chromate steel DIN rail to assure proper grounding. The use of other DIN rail materials (for example, aluminum and plastic) that can corrode, oxidize, or are poor conductors, can result in improper or intermittent grounding. Secure DIN rail to the mounting surface approximately every 200 mm (7.87 in.) and use end anchors appropriately.

Follow these guidelines when mounting the module:

- Use horizontal or vertical mounting. Secure the 35 mm (1.4 in.) wide DIN rail properly with fasteners every 200 mm (7.87 in.).
- Leave at least 15 mm (0.6 in.) to the wiring duct for adequate ventilation and room for wiring.
- Place all other heat sources an appropriate distance from the module to maintain the specified ambient temperature around the module.

10 CompactBlock Guard I/O EtherNet/IP Safety Modules

- Pry open the two gray latches to lock them in the open position. Hook the module over the top of the DIN rail. Rotate the module downward until it makes full contact with the DIN rail. Snap the latches back into place to secure the module to the rail. Verify that the module is securely attached to the DIN rail.

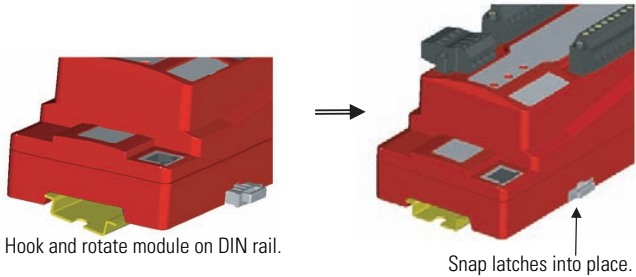

Module Identification and Dimensions

See the figure for module identification and dimensions.

Module Identification

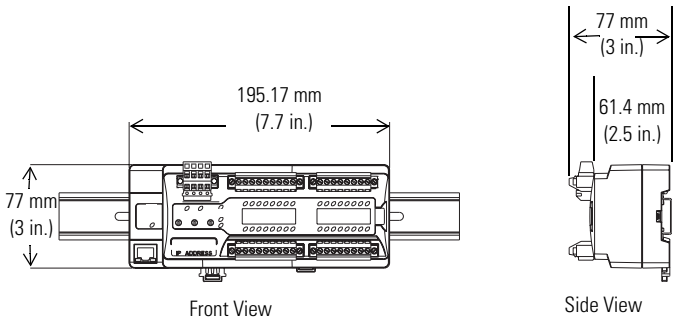

44203

Wiring the Module

Follow these guidelines when wiring the module:

- Do not route communication, input, or output wiring with conduit containing high voltage, referring to Industrial Automation Wiring and Grounding Guidelines, publication [1770-4.1](#).
- Wire correctly after confirming the signal names of all terminals.
- Note that stranded wire should be processed with insulation-covered ferrule (DIN 46228-4 standard compatible-type) at its ends before using for connection.
- Tighten screws for the power connector correctly at 0.56...0.79 N•m (5...7 lb•in).
- Tighten screws for the I/O connectors correctly at 0.5...0.56 N•m (4.5...5 lb•in).

Working with Connectors

See the figure that shows connectors.

Power and EtherNet/IP Connectors

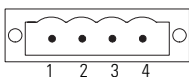

Power Configuration

Pin	Signal
1	Input +24V DC Power
2	Input Power Common
3	Output +24V DC Power ⁽¹⁾
4	Output Power Common ⁽¹⁾

⁽¹⁾ NC on 1791ES-IB16 modules.

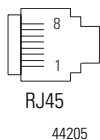

EtherNet/IP Connector

- 8 - No connection
- 7 - No connection
- 6 - Receive data minus
- 5 - No connection
- 4 - No connection
- 3 - Receive data plus
- 2 - Transmit data minus
- 1 - Transmit data plus

Observing Precautions for Safe Use

Read this for a list of precautions for safe use:

- Wire conductors correctly and verify operation of the module before commissioning the system in which the module is incorporated, noting that incorrect wiring may lead to loss of safety function.
- Do not apply DC voltages exceeding rated voltages to the module.
- Apply properly specified voltages to the module inputs. Note that applying inappropriate voltages causes the module to fail to perform its specified function, which leads to loss of safety functions or damage to the module.
- Do not use test outputs as safety outputs. Test outputs are not safety outputs.
- Be sure that qualified personnel confirm installation and conduct test operations and maintenance after installation of the module.
- Be sure that personnel familiar with machinery where the module is to be installed conduct and verify installation.
- Do not dismantle, repair, or modify the module. This may lead to loss of its safety function.
- Use only appropriate components or devices complying with relevant safety standards corresponding to the required level of safety categories (safety integrity level). Conformity to requirements of safety category (safety integrity level) is determined as an entire system. We recommend you consult a certification body regarding an assessment of conformity to the required safety level.
- You are responsible for compliance with applicable standards for the entire system.
- Disconnect the module from the power supply when wiring.

- Be sure that AC voltage is never applied to the module as module failure will result.

ATTENTION

Safety state of the module and its data is defined as the off state.

Serious injury can occur due to breakdown of safety outputs. Do not connect loads beyond the rated value of the safety outputs.

Serious injury can occur due to loss of required safety functions. Wire the module properly so that supply voltages or voltages for loads do not touch the safety outputs accidentally or unintentionally.

As serious injury can occur due to loss of safety functions, use appropriate devices as shown in the [Controlling Devices - Sample Requirements](#) table.

Controlling Devices - Sample Requirements

Device	Requirement	Allen-Bradley Bulletin Safety Components
Emergency stop switch	Use approved devices with direct opening mechanism complying with IEC/EN 60947-5-1.	Bulletin 800F, 800T
Door interlocking switch, limit switch	Use approved devices with direct opening mechanism complying with IEC/EN 60947-5-1 and capable of switching microloads of 24V DC 5 mA.	Bulletin 440K, 440G, or 440H for interlock switch, Bulletin 440P or 802T for limit switch
Safety sensor	Use approved devices complying with the relevant product standards, regulations, and rules in the country where used.	Any Allen-Bradley Guardmaster product
Relay with forcibly guided contacts	Use approved devices with forcibly guided contacts complying with EN 50205. For feedback purposes, use devices with contacts capable of switching microloads of 24V DC 5 mA.	Bulletin 700S, 100S
Other devices	Evaluate whether devices used are appropriate to satisfy requirements of safety category levels.	

Interpret the Status Indicators

See the figure and tables for information about how to interpret status indicators.

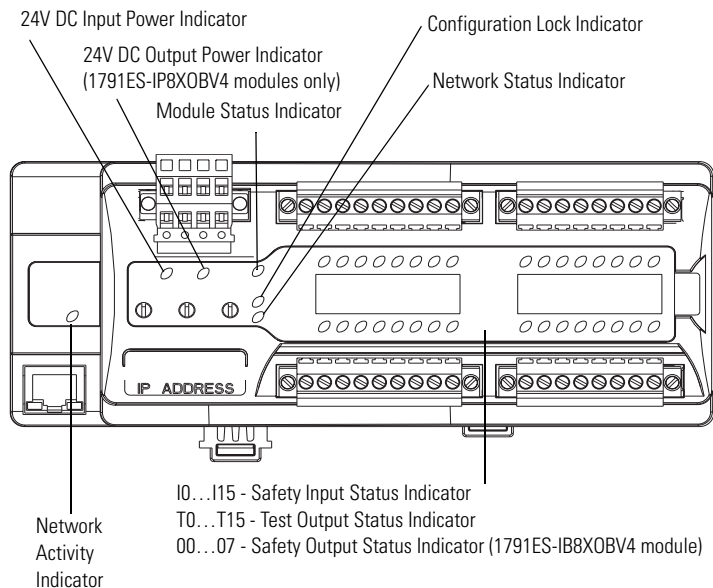

24V DC Input Power Indicator

State	Status	Description	Recommended Action
Off	No power	No power is applied.	Apply power to this section.
Solid green	Normal operation	The applied voltage is within specifications.	None.
Solid yellow	Input power out of specification	The input power is out of specification.	Check your configuration, wiring, and voltages and apply the changes.

24V DC Output Power Indicator

State	Status	Description	Recommended Action
Off	No power	No power is applied.	Apply power to this section.
Solid green	Normal operation	The applied voltage is within specifications.	None.
Solid yellow	Output power out of specification	The output power is out of specification.	Check your configuration, wiring, and voltages and apply the changes.

Module Status Indicator⁽¹⁾

State	Status	Description
Off	No power	No power is applied to the power connector.
Solid green	Normal operation	The module is operating normally.
Solid red	Unrecoverable fault	The module detected an unrecoverable fault.
Flashing green	Module needs commissioning due to missing, incomplete, or incorrect configuration	Module is unconfigured.

Module Status Indicator⁽¹⁾

State	Status	Description
Flashing red	Recoverable fault or user-initiated firmware update in progress	The module has detected a recoverable fault or user-initiated firmware update is in progress.
Flashing red and green	Device in self test	The module is performing its power-cycle diagnostic tests.

⁽¹⁾ For recommended action, refer to the user manual that covers these modules.

Network Status Indicator⁽¹⁾

State	Status	Description
Off	Module not online or no power	The module does not have an IP address.
Flashing green	Module online with no connections in established state	The module has acquired an IP address, but no connections are established.
Solid green	Module online with connections in established state	The module is operating normally.
Flashing red	One or more I/O connections in timed-out state or user-initiated firmware update in progress	The module detected a recoverable network fault, I/O connection timed out, or user-initiated firmware update is in progress.
Solid red	Critical link failure	The module detected an error that prevents it from communicating on the network, such as the Ethernet cable is unplugged.
Flashing red and green	Communication faulted module	The module detected a network access error and is in communication faulted state. The module received and accepted an Identity Communication Faulted Request-long protocol message.

⁽¹⁾ For recommended action, refer to the user manual that covers these modules.

Network Activity Indicator

State	Status
Off	No link established
Flashing green/off	Transmit or receive activity
Steady green	Link established

Safety Input Status Indicator

State	Status	Description	Recommended Action
Off	Safety input off or module being configured	The safety input is off or the module is being configured.	Turn the safety input on or wait for the module to be configured.
Solid yellow	Safety input on	The safety input is on.	None.
Solid red	Fault detected	A fault in the external wiring or input circuit detected.	Check configuration, field wiring, and devices. If no problem found, replace module.
Flashing red	Partner fault detected	A fault in the partner input circuit of a dual input configuration detected.	Check the field wiring and verify your configuration for the partner circuit. If no problem found, replace module.

Test Output Status Indicator

State	Status	Description	Recommended Action
Off	Test output off or module being configured	The test output is off or the module is being configured.	Turn the test output on or wait for the module to be configured.
Solid yellow	Output is on	Output is on.	None.
Solid red	Fault detected	A fault in the external wiring or input circuit detected.	Check field wiring. If no problem found, replace module. For outputs configured for muting could indicate undercurrent or burned-out lamp.

Safety Output Status Indicator (1791ES-IB8XOBV4 module only)

State	Status	Description	Recommended Action
Off	Safety output off or module being configured	The safety output is off or the module is being configured.	Turn the safety output on or wait for the module to be configured.
Solid yellow	Safety output on	The safety output is on.	None.
Solid red	Fault detected	A fault in the output circuit was detected.	Check the circuit wiring and end device. If no problem found, replace module.
		Both tags in a dual channel circuit do not have the same value.	Make sure logic is driving tag values to the same state (off or on).
Flashing red	Partner fault detected	A fault in the partner of a dual output circuit was detected.	Check the circuit wiring and end device of the partner. If no problem found, replace module.

Configuration Lock Indicator⁽¹⁾

State	Status	Description	Recommended Action
Off	No configuration	Invalid configuration data.	None
Solid yellow	Locked	Valid configuration, locked by a network configuration tool such as RSNetWorx for EtherNet/IP software.	None
Flashing yellow	Not locked	Valid configuration, owned by a network configuration tool such as RSNetWorx for EtherNet/IP software.	None

⁽¹⁾ Not applicable to GuardLogix controllers.

Terminal Positions

See the figure and table for terminal positions. For wiring diagrams, see the user manual that covers these modules.

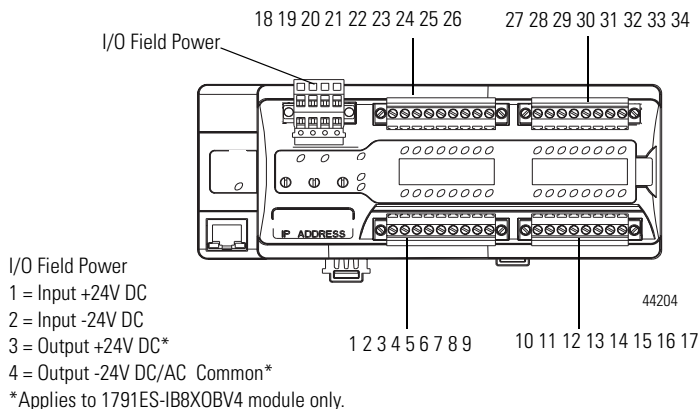

Terminal Positions for Terminal Numbers 1...18

Number	Terminal	Number	Terminal
1	Functional earth	10	Safety input 4
2	Safety input 0	11	Safety input 5
3	Safety input 1	12	Test output 4
4	Test output 0	13	Test output 5
5	Test output 1	14	Safety input 6
6	Safety input 2	15	Safety input 7
7	Safety input 3	16	Test output 6
8	Test output 2	17	Test output 7/muting
9	Test output 3/muting		

Terminal Positions for Numbers 19...34

Number	Terminal for 1791ES-IB8XOBV4 Module	Terminal for 1791ES-IB16 Module
18	Functional earth	Functional earth
19	Safety output 0 ⁽¹⁾ /switch +24V DC	Safety input 8
20	Safety output 1 ⁽¹⁾ /switch 24V DC common	Safety input 9
21	L-/24V DC common	Test output 8
22	S+/24V DC	Test output 9
23	Safety output 2 ⁽¹⁾ /switch +24V DC	Safety input 10
24	Safety output 3 ⁽¹⁾ /switch 24V DC common	Safety input 11/muting
25	L-/24V DC common	Test output 10
26	S+/24V DC	Test output 11
27	Safety output 4 ⁽¹⁾ /switch +24V DC	Safety input 12
28	Safety output 5 ⁽¹⁾ /switch 24V DC common	Safety input 13
29	L-/24V DC common	Test output 12
30	S+/24V DC	Test output 13
31	Safety output 6 ⁽¹⁾ /switch +24V DC	Safety input 14
32	Safety output 7 ⁽¹⁾ /switch 24V DC common	Safety input 15
33	L-/24V DC common	Test output 14
34	S+/24V DC	Test output 15/muting

⁽¹⁾ Safety outputs can only be used as pairs.
 Safety outputs 0/1 must be controlled as a pair.
 Safety outputs 2/3 must be controlled as a pair.
 Safety outputs 4/5 must be controlled as a pair.
 Safety outputs 6/7 must be controlled as a pair.

Specifications

Guard I/O EtherNet/IP Safety Module - 1791ES-IB8XOBV4, 1791ES-IB16

Attribute	Value
Safety Input	
Input types	Current sinking
Voltage, on-state Input, min	11V DC
Current, on-state Input, min	3.3 mA
Voltage, off-state input, max	5V DC
Current, off-state, max	1.3 mA
IEC 61131-2 (input type)	Type 3
Pulse Test Output	
Output type	Current sourcing
Pulse test output current	0.7 A per output 8 A total module @ 40 °C (104 °F) 6 A total module @ 60 °C (140 °F) for 1791ES-IB8XOBV4 module (see temperature versus current derating) 8 A total module @ 60 °C (140 °F) for 1791ES-IB16 module
Residual voltage, max	1.2V
Output leakage current, max	0.1 mA
Short circuit protection	Yes
Current, max (when used to control muting lamp)	25 mA Current, max (to avoid fault when used as a muted lamp output)
Current, min (when used to control muting lamp)	5 mA Current, min (at which fault indication is generated when used as a muted lamp output)

Guard I/O EtherNet/IP Safety Module - 1791ES-IB8XOBV4, 1791ES-IB16

Attribute	Value
Safety Output	
Output types	Current sourcing/current sinking - bipolar pair
Output current rating	2 A max per point 8 A total module @ 40 °C (104 °F) (see temperature versus current derating) 6 A total module @ 60 °C (140 °F)
On-state voltage drop	+/- 0.6V
Leakage current	+/- 1.0 mA ⁽¹⁾
Internal resistance from P to M terminal	3.25 kΩ
Short circuit detection	Yes (short high and low and cross-circuit fault detect)
Short circuit protection	Electronic
Aggregate current of module	8 A @ 40 °C (104 °F) 6 A @ 60 °C (140 °F) (see product temperature versus current derating)
Pilot duty rating	2.5 A inrush for 1791ES-IB8XOBV4 module
Number of outputs	4 dual channel

⁽¹⁾ Includes the presence of a single P stuck-high or M stuck-low short.

General

Attribute	Value
North American temp code	T4A
Enclosure type rating	Meets IP20
Communication current consumption	250 mA at 24V DC
Operating voltage range	19.2...28.8V DC (24V DC, -20...20%)

General

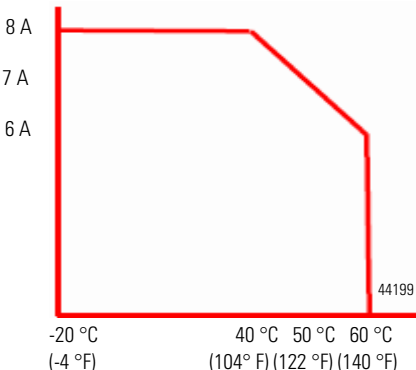
Attribute	Value
Isolation voltage	1791ES-IB16 - 50V (continuous), Basic Insulation - Type tested at 800VDC for 60 s between input channels and network 1791ES-IB8XOBV4 - 50V (continuous), Basic Insulation - Type tested at 800V DC for 60 s between input and output channels and between I/O and network
Product temperature versus current derating (for 1791ES-IB8XOBV4 module only)	 <p data-bbox="398 929 885 990">Product Temperature Versus Current Derating (combined current from both input and output supplies)</p>
Wiring category ⁽¹⁾	2 - on signal ports, 2 - on power ports, 2 - on communication ports
Wire size	Power and I/O wiring: 0.34...1.5 mm ² (22...16 AWG) solid or stranded copper wire rated at 75 °C (167 °F) or greater 1.2 mm (3/64 in.) insulation max
Weight, approx.	600 g (1.32 lb)
Dimensions (HxWxD), approx.	80 x 196 x 77 mm (3.2 x 7.7 x 3 in.) with terminal block
	77 x 196 x 62 mm (3 x 7.7 x 2.5 in.) without terminal block

⁽¹⁾ Use this Conductor Category information for planning conductor routing. Refer to Industrial Automation Wiring and Grounding Guidelines, publication [1770-4.1](#).

Environmental Specifications

Attribute	Value
Temperature, operating	IEC 60068-2-1 (Test Ad, Operating Cold), IEC 60068-2-2 (Test Bd, Operating Dry Heat), IEC 60068-2-14 (Test Nb, Operating Thermal Shock): -20...60 °C (-4...140 °F)
Temperature, nonoperating	IEC 60068-2-1 (Test Ab, Unpackaged Nonoperating Cold), IEC 60068-2-2 (Test Bb, Unpackaged Nonoperating Dry Heat), IEC 60068-2-14 (Test Na, Unpackaged Nonoperating Thermal Shock): -40...85 °C (-40...185 °F)
Relative humidity	IEC 60068-2-30 (Test Db, Unpackaged Damp Heat): 5...95% noncondensing
Vibration	IEC 60068-2-6 (Test Fc, Operating): 5 g at 10...500 Hz
Shock, operating	IEC 60068-2-27 (Test Ea, Unpackaged Shock): 30 g
Shock, nonoperating	IEC 60068-2-27 (Test Ea, Unpackaged Shock): 50 g
Emissions	CISPR 11: Group 1, Class A
ESD Immunity	IEC 61000-4-2: 8 kV contact discharges 10 kV air discharges
Radiated RF immunity	IEC 61000-4-3: 10V/m with 1 kHz sine-wave 80% AM from 80...2000 MHz 10V/m with 200 Hz 50% Pulse 100% AM at 900 MHz 10V/m with 200 Hz 50% Pulse 100% AM at 1890 MHz 3V/m with 1 kHz sine-wave 80% AM from 2000...2700 MHz
Conducted RF immunity	IEC 61000-4-6: 10V rms with 1 kHz sine-wave 80%AM from 150 kHz...80 MHz
EFT/B immunity	IEC 61000-4-4: ±4 kV at 5 kHz on power ports ±3 kV at 5 kHz on signal ports ±2 kV at 5 kHz on communication ports

Environmental Specifications

Attribute	Value
Surge transient immunity	IEC 61000-4-5: ± 1 kV line-line (DM) and ± 2 kV line-earth (CM) on power ports ± 1 kV line-line (DM) and ± 2 kV line-earth (CM) on signal ports ± 2 kV line-earth (CM) on communication ports
Reaction Time	
Input reaction time, max	16.2 ms + set values of ON/OFF delays
Output reaction time, max	6.2 ms + (20 ms) relay response time (1791ES-IB8XOBV4 module only)

Signal Sequence

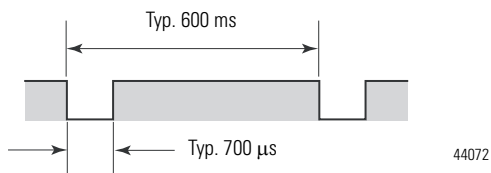

While safety outputs are in an on state, the signal sequence shown in the figure is output continuously for fault diagnosis when pulse testing is enabled. Confirm response time of device connected to safety outputs so the device does not malfunction due to off pulse.

Certifications

Certification	Value	
Certifications (when product is marked) ⁽¹⁾	c-UL-us	UL Listed Industrial Control Equipment, certified for US and Canada. See UL File E65584. UL Listed for Class I, Division 2 Group A,B,C,D Hazardous Locations, certified for U.S. and Canada. See UL File E194810.
	CE	European Union 2004/108/EC EMC Directive, compliant with: EN 61326-1; Meas./Control/Lab., Industrial Requirements EN 61000-6-2; Industrial Immunity EN 61000-6-4; Industrial Emissions EN 61131-2; Programmable Controllers (Clause 8, Zone A & B)
	C-Tick	Australian Radiocommunications Act, compliant with: AS/NZS CISPR 11; Industrial Emissions
	Ethernet /IP	ODVA conformance tested to EtherNet/IP specifications
	TÜV	TÜV Certified for Functional Safety up to and including Category 4 and SIL 3 ⁽²⁾

⁽¹⁾ See the Product Certification link at <http://www.ab.com> for Declarations of Conformity, Certificates, and other certification details.

⁽²⁾ When used with specified firmware revisions.

CompactBlock Guard I/O, Logix5000, RSNetWorx for EtherNet/IP, Allen-Bradley, and Rockwell Automation are trademarks of Rockwell Automation, Inc.

Trademarks not belonging to Rockwell Automation are property of their respective companies.

www.rockwellautomation.com

Power, Control and Information Solutions Headquarters

Americas: Rockwell Automation, 1201 South Second Street, Milwaukee, WI 53204 USA, Tel: (1) 414.382.2000, Fax: (1) 414.382.4444

Europe/Middle East/Africa: Rockwell Automation, Vorstlaan/Boulevard du Souverain 36, 1170 Brussels, Belgium, Tel: (32) 2 663 0600, Fax: (32) 2 663 0640

Asia Pacific: Rockwell Automation, Level 14, Core F, Cyberport 3, 100 Cyberport Road, Hong Kong, Tel: (852) 2887 4788, Fax: (852) 2508 1846

Publication 1791ES-IN001C-EN-P - September 2009

PN-51108

Supersedes Publication 1791ES-IN001B-EN-P - April 2009

Copyright © 2009 Rockwell Automation, Inc. All rights reserved. Printed in the U.S.A.